

NOM PRÉNOM DATE

ÉVALUATION II

CRITÈRES D'ÉVALUATION

TRACÉ :

☉ bien maîtrisé

☉ orienté
correctement

☉ limité
dans l'espace

☉ régulier

☉ continu

Réduction
de l'amplitude
du geste

Bonne pression
sur l'outil

Enchaînement
correct
des tracés

--	--	--	--	--	--	--	--

Écris la lettre T.



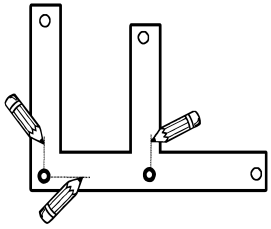
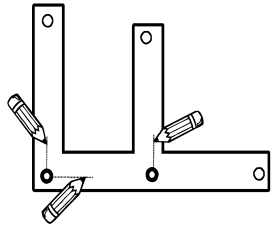
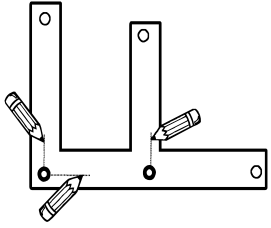
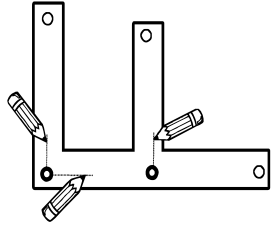
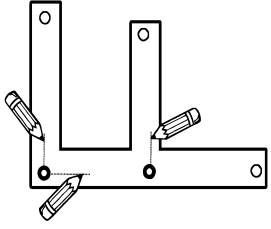
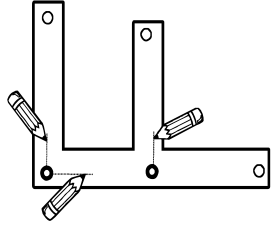
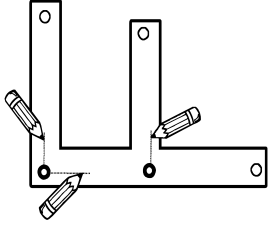
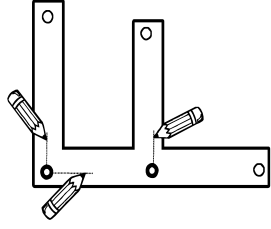
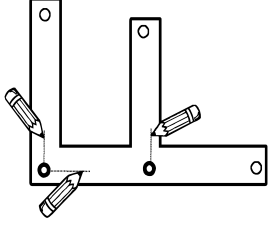
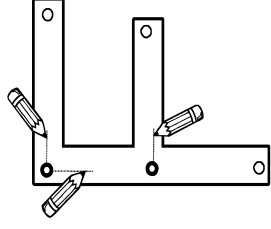

Atelier ECRITURE : J'apprends à écrire des lettres.



Prénom:

Date:

LOGIQUE 3

Compétences: - Trier des éléments selon un critère

- Construire deux ensemble en rassemblant des objets ayant une propriété commune

● **Consigne :** Il faut ranger..Colle les fruits sur la table et vêtements dans l armoire.

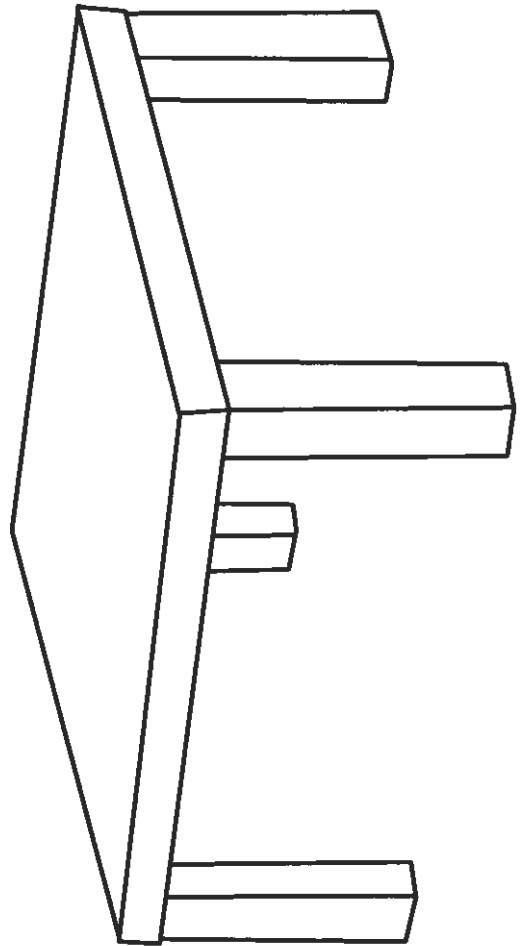
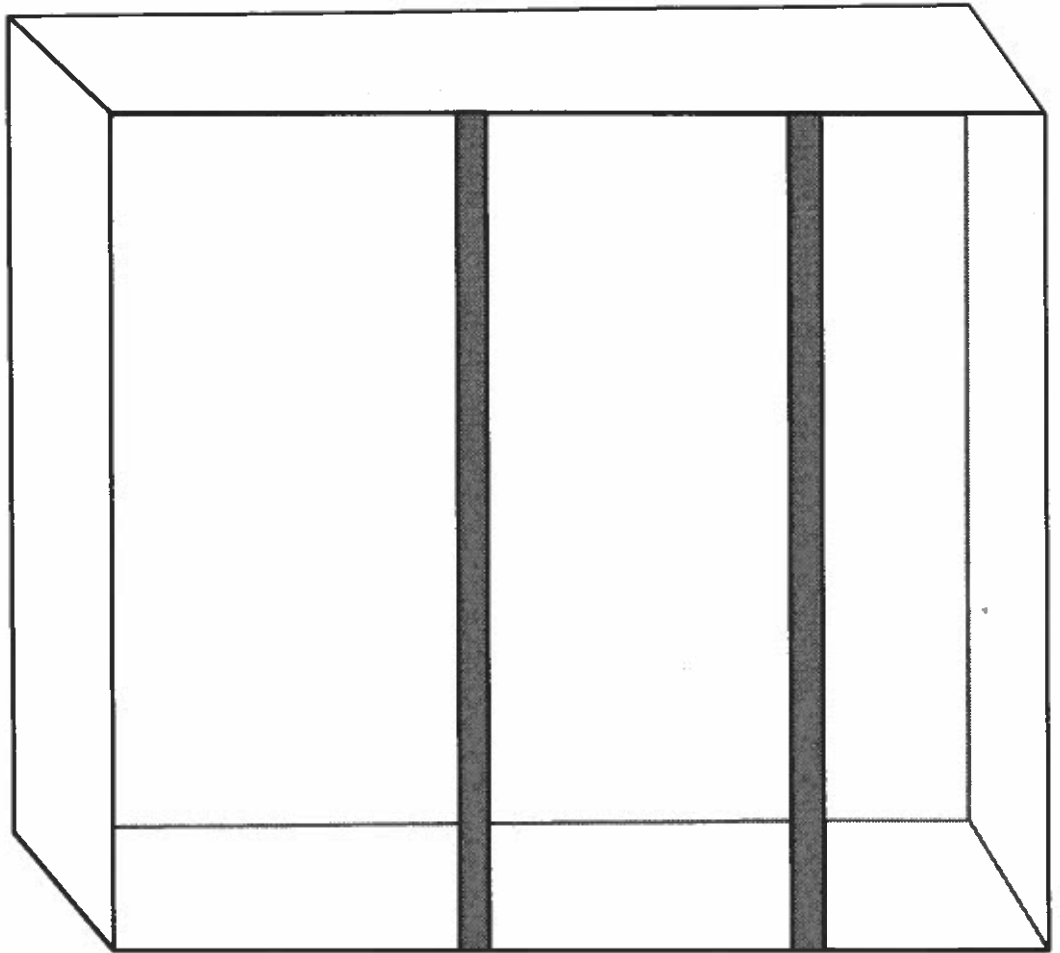

A découper pour 3 enfants (Fiche Logique 3)

